



ROOF TENT INSTRUCTIONS
HERO SKYBOX



www.herocamper.com
E-mail: hello@herocamper.com



GET OUT AND STAY HOME



2.c It is possible to verify weight variations in the range of 10%, as the Hero Skybox roof tent are a hand craft product realized through accurate manual techniques. Do not exceed maximum load allowed on the roof given by the vehicle's manufacturer, and when calculating the carriable load, it is recommended to take aforementioned factor in consideration. Also consider the weight of the roof racks and possible items stored inside the tent.

2.d Always check the load fixing and whether the tent is perfectly closed before driving.

2.e During driving pauses it is also recommended.

2.f Be aware of not to exceed the maximum load for transport indicated on the vehicle registration document, and do not exceed the maximum load specified in the assembly instruction. The manufacturer declines any responsibility for any accidents due to wrong maintenance, improper use or non-respect of general rules concerning the use of the product.

2.g Do not leave kids unattended inside the product

2.h Be aware of the total height of the vehicle allowed in covered parking and subways. Also, be aware of following obstacles: street signals and advertising, trees, barriers, prominent rocks and so on.

2.i When washing the car in an automatic car wash with rolls, be sure the car wash allows car + tent washing.

2.j Never transport inflammable or dangerous objects inside the product.

2.k Do not use the product during extraordinary weather conditions (typhoons, hurricane, overflows, flows, land slide etc.) or when wind speeds are more than 30 km/h or 17 knots.

WARRANTY

1.a Normal wear and tear or improper use of the components are not covered by the warranty.

1.b The condition for warranty validity is that the defect product must be returned by the purchaser to the dealer, in which it has been purchased together with the till receipt.

1.c Within 10 days from delivery any possible visual defects must be communicated to the manufacture substantiated by pictures and the serial number of the product.

1.d It is not allowed to return the product to the manufacture without a written authorization from the manufacture. Hero Campers official website.

1.e Returns of used products are not allowed.

1.f The purchaser will not cover any freight costs if the product is not covered by the warranty and a repair will be carried out at reasonable costs.

1.g The manufacture must provide at his discretion for the replacement or repairing of the product.

1.h The warranty decays in case of interventions not carried out by the manufacturer.



2.a It is necessary to suitably lower speed, as the any element on the roof of the vehicle alters its standard conditions.

2.b It is necessary to consider traffic, quality of roadbed, environmental and weather conditions before driving with the product.

SKYBOX MANUAL

Let the sky be the limit with the perfect addition to your Hero Camper or your car. Hero Skybox offers generous space for three adults or four kids, easy close gas-spring system, durable ABS shell and a rugged construction designed in Denmark.



HERO SKYBOX sets the new standard for rugged and comfortable roof mounted sleeping facilities.

SPECIFICATIONS

Spring system:	Self opening gas springs with soft close
Mattress material:	Comfortable Sponge
Mattress length:	201 cm / 6 ft 7.1 in
Mattress width:	181 cm / 5 ft 11.3 in
Height (internal):	110 cm / 3 ft 7.3 in
Load capacity (camping):	300 kg / 661 lbs
Weight:	90 kg / 199 lbs
Material:	ABS and all-weather fabric
Awning:	Rip-stop polyester-cotton canvas
Use on:	Hero Camper or car

TECHNICAL DETAILS

We used sturdy aluminum base, UV resistant fabric. A combination of stainless steel and gas springs for the expansion structure. The Hero Skybox tent has extraordinary expandable space.



The mosquito net has a fine weft: 24x24 threads per square inch [24x24/ square inch] and are very soft and resistant.

No matter which kind of roof bars you have on your vehicle the two channel aluminum bars in guides allow you to install the tent easy and without complications (normally without any additional fixings).

START USE

OPEN SKYBOX

1. Unlock buckles



2. Open Skybox



3. Pull rope done and lock it on the bottom

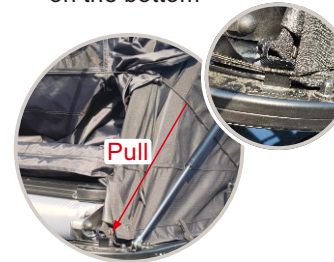

4. Stretch the ladder totally. Unfold Skybox by pull ladder down.

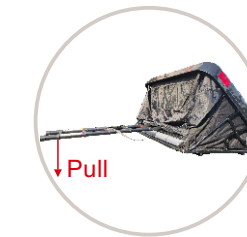

5. Pull the ladder up to the maximum. Pull the door stay out totally and lock it.



6. Insert safety pin

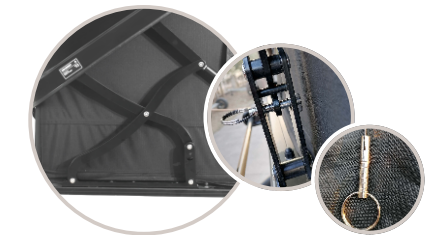

START USE

SIDE WINDOW STRUT ASSEMBLING



1. Insert strut into base



2. Insert strut into fabric



MEASUREMENTS

SKYBOX CLOSED



SKYBOX OPEN

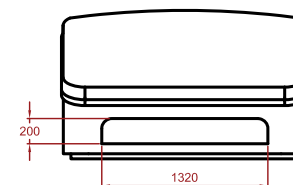
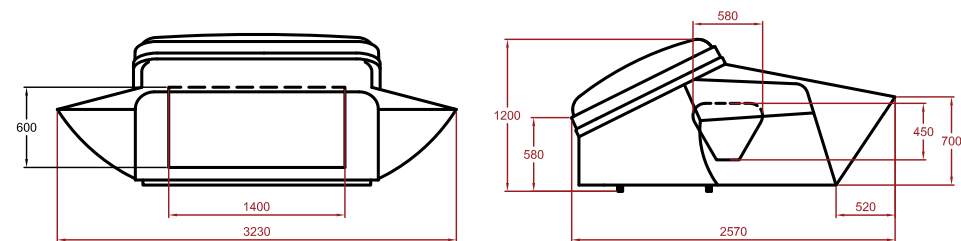

UNDERNEATH

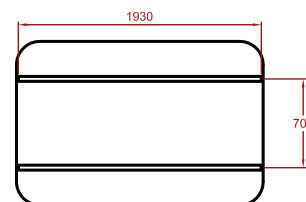

MATERIALS

We built in features to ensure the comfort is assured in extremes of climate, and we have designed the roof tent to be waterproof, windproof and breathable. To insulate the tent from heat, cold and external light we use good material.

THE ADVANTAGES OF OUR MATERIAL



BREATHABLE:

It make sure the heat and humidity does not form condensation.



WATERPROOF:

It is not necessary to give the tent any kind of waterproof treatment, as the rind do not retain water and that give you the option to fold the tent even it is wet.



STRENGTH:

The fabric is very resistant against dirt and tear caused by the strong weft fibers. The fabric will not expand or shrink in changing weather conditions.

START USE

Points to note before closing SKYBOX

1. Remove safe pin



2. Unlock and pull door stay back totally



3. Pull fabric totally into tent



4. Adjust the straps to make the tent close tightly enough



MOUNTING

PLEASE NOTE:

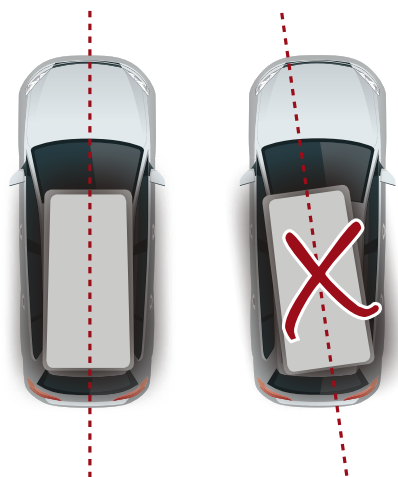
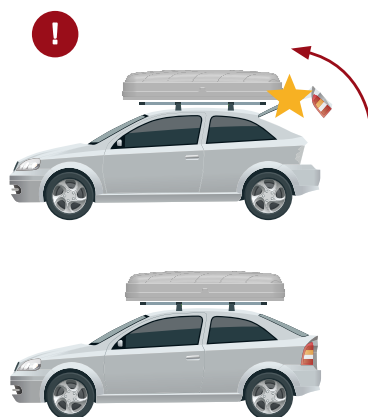
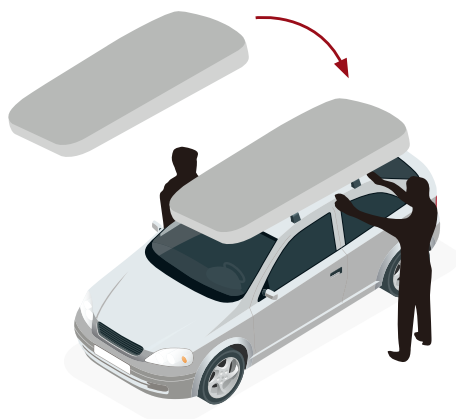

FABRIC TECHNICAL DATA

Coating:	PU coating
Total weight	280 g/m ² (EN ISO 2286-2)
Base fabric	Polyester-mixed cotton (DIN ISO 2076)
Solar protection factor	50 (UV Standard 801)
Temperature resistance	-40 °C / +70°C (DIN EN 1876-1 / PA 07.04)
Water repellent	3000mm
Waterproof	Yes

CLEANING RECOMMENDATION

To store the assembly parts it is requested to keep the product dry and clean from dirt. In case of improper storage, it can cause fungicidal in the fabric and consequently the material can lose its strength in the affected material.

The cleaning of the fabric can be done manually with a soft sponge with warm water around 30°C and common detergents. After thorough rinsing it is important to dry the material completely. When cleaning larger objects, it is possible to use an industrial washing machine with max temperature on max 40°C with subsequent drying. This fabric can be disposed via normal household, please find information in your local legislation.

MOUNTING

TOP BRACKET DIMENSION REQUIREMENTS

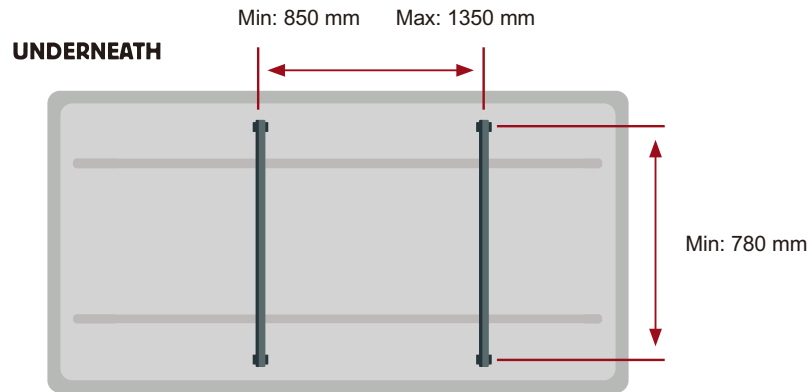

ROOF MOUNT

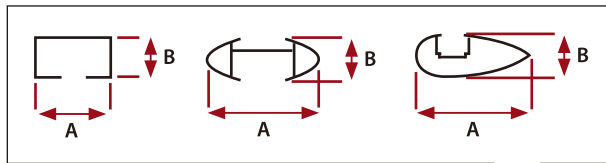

A | Min: 35 mm
Max: 85 mm

B | Min: 25 mm
Max: 43 mm



MOUNTING

- 1 **INSERT**
- 2
- 3 **HOLD UP** **MOVE**
- 4 **PUT DOWN**
- 5

Tightening torque should be between 12 to 14 Nm